

### Datasheet

Subject to technical alteration  
Issue date: 14.08.2020 • A110



### » APPLICATION

Differential pressure and volume flow transducer for monitoring differential pressure and volume flow of air and other non-flammable and non-aggressive gases. Three types with eight different measuring ranges are available for different applications. In addition to differential pressure all variants provide the calculated volume flow as second analog output signal. K-values for flow calculation (default 1500) can be parameterized via Thermokon USEapp. The mounting base (included in delivery) allows mounting on a level surface or mounting on DIN rail TS35 (35x7,5 mm) according to EN 60715.

### » TYPES AVAILABLE

#### Differential pressure and volume flow transducer – RS485 Modbus

DPA250+ RS485 Modbus MultiRange <AZ>  
DPA2500+ RS485 Modbus MultiRange <AZ>  
DPA7000+ RS485 Modbus MultiRange <AZ>

#### Differential pressure and volume flow transducer and 2 digital inputs – RS485 Modbus

DPA250+ RS485 Modbus MultiRange <AZ> 2IN  
DPA2500+ RS485 Modbus MultiRange <AZ> 2IN  
DPA7000+ RS485 Modbus MultiRange <AZ> 2IN

MultiRange: Measuring ranges adjustable at the transducer  
<AZ>: automatic zero-point calibration (optional)

### » SECURITY ADVICE – CAUTION



The installation and assembly of electrical equipment should only be performed by authorized personnel.

The product should only be used for the intended application. Unauthorised modifications are prohibited! The product must not be used in relation with any equipment that in case of a failure may threaten, directly or indirectly, human health or life or result in danger to human beings, animals or assets. Ensure all power is disconnected before installing. Do not connect to live/operating equipment.

Please comply with

- Local laws, health & safety regulations, technical standards and regulations
- Condition of the device at the time of installation, to ensure safe installation
- This data sheet and installation manual

## » NOTES ON DISPOSAL



As a component of a large-scale fixed installation, Thermokon products are intended to be used permanently as part of a building or a structure at a pre-defined and dedicated location, hence the Waste Electrical and Electronic Act (WEEE) is not applicable. However, most of the products may contain valuable materials that should be recycled and not disposed of as domestic waste. Please note the relevant regulations for local disposal.

## » PRODUCT TESTING AND CERTIFICATION



### Declaration of conformity

The declaration of conformity of the products can be found on our website <https://www.thermokon.de/>.

## » USE ENCLOSURE WITH UV AND WEATHER RESISTANCE

Outdoor plastic enclosures age over time, fade or form microcracks on the surface. USE housings are therefore made of white polycarbonate (PC) with titanium dioxide and the lightest stable additives. Due to the reflection of the entire light spectrum including the UV component, the titanium dioxide effectively counteracts the photochemical degradation of polymer, whereby the colors remain saturated longer. The material is also resistant to cold and frost.

## » TECHNICAL DATA

<b>Measuring values</b>	differential pressure, volume flow		
<b>Medium</b>	air or other non-flammable/non-aggressive gases		
<b>Output voltage</b>	0..10 V or 0..5 V, min. load 10 kΩ (live-zero configuration via Thermokon USEapp)		
<b>Network technology</b>	RS485 Modbus, RTU, half-duplex, baud rate 9.600, 19.200, 38.400 or 57600, parity: none (2 stopbits), even or odd (1 stopbit)		
<b>Power supply</b>	15..35 V = or 19..29 V ~ SELV		
<b>Power consumption</b>	max. 2,3 W (24 V =)   max. 4,3 VA (24 V ~)		
<b>Measuring range velocity</b>	0... 750.000 m³/h (default), optionally configured via Thermokon USEapp		
<b>Measuring range pressure</b> <small>*selectable at the device</small>	<b>type 250</b> 0..+25   0..+50   0..+100   0..+250   -25..+25   -50..+50   - 100..+100   -150..+150 Pa	<b>type 2500</b> -100..+100   0..+100   0..+250   0..+500   0..+1000   0..+1500   0..+2000   0..+2500 Pa	<b>type 7000</b> 0..+1000   0..+1500   0..+2000   0..+2500   0..+3000   0..+4000   0..+5000   0..+7000 Pa
<b>Accuracy pressure</b> <small>*deviation from calibration reference device (calibrator)</small>	±1 Pa at range <250 Pa	±5 Pa at range <500 Pa, ±10 Pa at range >500 Pa	±10 Pa at range <2000 Pa, ±25 Pa at range >2000 Pa
<b>Max. working overpressure</b>	40 kPa		
<b>Calibration</b>	manually, automatic zero-point calibration (optional)		
<b>Inputs</b> <small>(optional)</small>	<b>2IN</b> 2x input for NTC10k or floating contact		
<b>Sensor</b>	piezo measuring element		
<b>Enclosure</b>	enclosure USE-L, PC, pure white, with removeable cable entry, UV resistant		
<b>Protection</b>	IP65 according to EN 60529		
<b>Cable entry</b>	M25, for wire max. Ø=7 mm , seal insert for fourfold cable entry		
<b>Connection electrical</b>	<b>Mainboard</b> removeable plug-in terminal, max. 2,5 mm²	<b>Plug-in card</b> removeable plug-in terminal, max. 1,5 mm²	
<b>Connection mechanical</b>	pressure connection male Ø=5,0 mm / Ø=6,3 mm, connection tube: PVC, soft		
<b>Ambient condition</b>	-10..+50 °C, max. 85% rH short term condensation		
<b>Mounting</b>	screw mounted onto flat surface, prepared for mounting on DIN rail TS35 (35x7,5 mm) according to EN 60715		

» **MOUNTING ADVICES**

Before installing the device, please check the leak tightness of the pressure lines. A prerequisite for the operation is a proper installation of all electrical supply, control and sensing leads as well as the pressurized connection line.

- In order to connect the device, the process lines must be unpressurized
- Consider the suitability of the device for the medium to be measured
- Consider maximum pressures

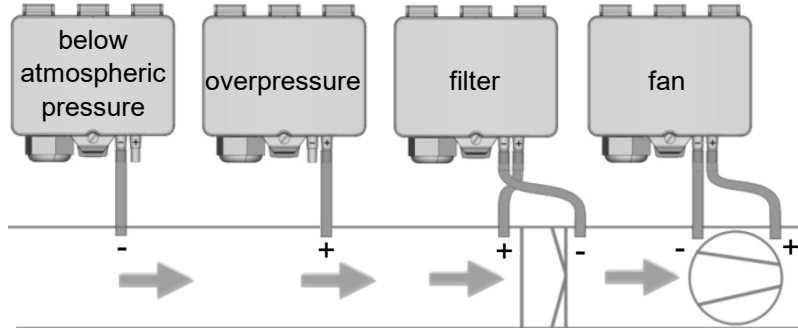

» **CONNECTION PLAN**

RS485 cable is looped through, connect both cable shields using the enclosed 2-pol. Connect terminal as shown.

DPA+ RS485 Modbus MultiRange

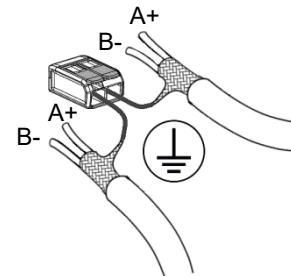
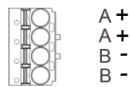
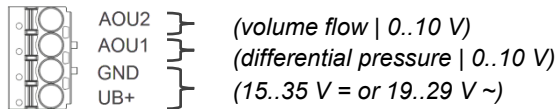
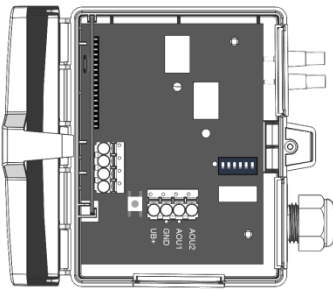

optional additional 2 digital inputs - 2IN

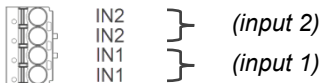

**Measuring range adjustment – type 250 | 2500 | 7000**

ON								ON	OFF
1	2	3	1	2	3	1	2	3	
0..+250	0..+100	0..+50	0..+25	-25..+25	-50..+50	-100..+100	-150..+150		Pa
0..+2500	0..+2000	0..+1500	0..+1000	0..+500	0..+250	0..+100	-100..+100		Pa
0..+7000	0..+5000	0..+4000	0..+3000	0..+2500	0..+2000	0..+1500	0..+1000		Pa
0..+1	0..+0.4	0..+0.2	0..+0.1	-0.1..+0.1	-0.2..+0.2	-0.4..+0.4	-0.6..+0.6		inchWC
0..+10	0..+8	0..+6	0..+4	0..+2	0..+1	0..+0.4	-0.4..+0.4		inchWC
0..+28	0..+20	0..+16	0..+12	0..+10	0..+8	0..+6	0..+4		inchWC

default

Response time		Output voltage		Unit	
ON	ON	ON	ON	ON	ON
4	4	5	5	6	6
0,8 sec	4,0 sec	0..10 V	0..5 V	Pa	inchWC
default		default		default	

**Dip switches, plug-in card**

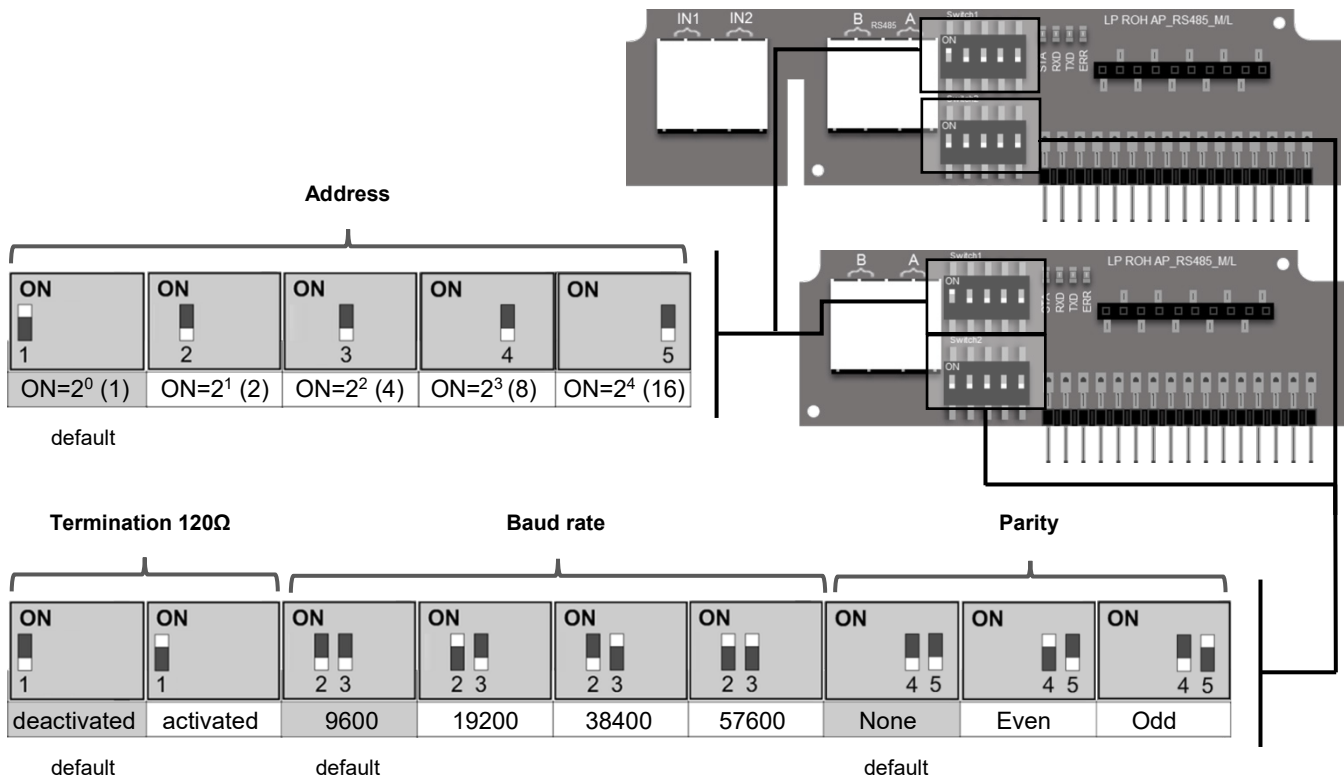

Flow calculation: (default parameters)

$$q = k * \sqrt{2 * \frac{\Delta p}{\rho}}$$

with k=1500, fan manufacturer Rosenberg, Comefri, Nicotra Gebhardt, default measuring range 0..750.000 m³/h.

**Further calculation formulas, fan manufacturers and k-values can be selected via the USEapp.**

Rosenberg · Comefri · Gebhardt · Nicotra	Ziehl-Abegg · EBM-Papst	Fläkt Woods
$q = k * \sqrt{2 * \frac{\Delta p}{\rho}}$	$q = k * \sqrt{\Delta p}$	$q = \frac{1}{k} * \sqrt{\Delta p}$

**Register 400 = 1 (Unit SI)**

Address	Access	Description	Resolution / Unit		
8	R / s16	<b>Differential pressure 1</b>	SI	1.0	Pa
9	R / u16	<b>Volumetric flow 1 (16 Bit)</b> (if register address 404 is set to the value 2, the value scales the unit m³/s)	SI	100.0	m³/h m³/s
50 Low	R / u32	<b>Volumetric flow 1 (32 Bit)</b> (if register address 404 is set to the value 2, the value scales the unit m³/s) <i>This register is available since firmware V1.6 (see register 505)</i>	SI	1.0	m³/h m³/s
51 High					

**Register 400 = 2 (Unit Imperial)**

Address	Access	Description	Resolution / Unit		
8	R / s16	<b>Differential pressure 1</b>	Imperial	0.001	inWC
9	R / u16	<b>Volumetric flow 1 (16 Bit)</b> (if register address 404 is set to the value 2, the value scales the unit m³/s)	Imperial	10.0	cfm

50 Low	R / u32	<b>Volumetric flow 1 (32 Bit)</b> (if register address 404 is set to the value 2, the value scales the unit m <sup>3</sup> /s)  <i>This register is available since firmware V1.6 (see register 505)</i>	Imperial	1.0	cfm
51 High					

**Optional (IN1 | IN2)**

NTC10k temperature sensors or floating contacts can be connected to the inputs (IN1 & IN2).

Address	Access	Description	Values	
92	R / s16	Input 1 – Switch contact	0	Contact open
93	R / s16	Input 2 – Switch contact	1	Contact closed

**Register 400 = 1 (Unit SI)**

Address	Access	Description	Resolution / Unit		
90	R / s16	Input 1 - Temperature NTC10k (beta value configurable, register address 490, default: 3864)	SI	0.1	°C
91	R / s16	Input 2 - Temperature NTC10k (beta value configurable, register address 491, default: 3864)	SI	0.1	°C

**Register 400 = 2 (Unit Imperial)**

Address	Access	Description	Resolution / Unit		
90	R / s16	Input 1 - Temperature NTC10k (beta value configurable, register address 490, default: 3864)	Imperial	0.1	°F
91	R / s16	Input 2 - Temperature NTC10k (beta value configurable, register address 491, default: 3864)	Imperial	0.1	°F

The modbus address of the device is set in the range of 1 ... 31 (binary encoded) using a 5-pole DIP switch. With address 0 via DIP, an extended address range (32..247) is available via USEapp.



**Modbus addresses:**

USE-RS485 Modbus Interface

A detailed description of the Modbus addresses can be found under the following link:

→ [Download](#)

**» AUTOMATIC ZERO-POINT CORRECTION - (OPTIONAL)**



**Transmitters equipped with the auto-zero correction are maintenance free.**

The auto-zero correction electronically adjusts the transmitter zero every 10 minutes. The function eliminates all output signal drift due to thermal, electronic or mechanical effects. The auto-zero correction takes approx. 4 seconds after which the device returns to its normal measuring mode. During the 4 second correction period, the output and display values will freeze to the latest measured value.

**» MANUAL ZERO-POINT CORRECTION (FOR DEVICES WITHOUT AUTO-ZERO FUNCTION)**

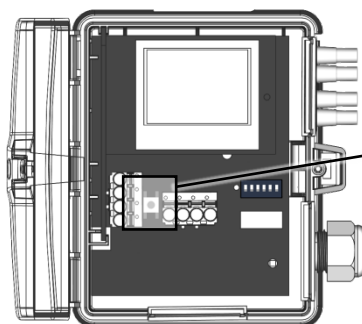

In normal operation zero point correction should be executed every 12 months.

**Attention! For executing zero point correction the power supply must be connected one hour before.**

- Release both connection tubes from the pressure terminals + and -
- Press the button until the LED lights permanently
- Wait until the LED flashes again and reinstall the connection tubes to the pressure ports (note + and -)

## » CONFIGURATION



The Thermokon bluetooth dongle with micro-USB is required for communication between USEapp and USE-M / USE L (Item No.: 668262). Commercial bluetooth dongles are not compatible.

Application-specific reconfiguration of the devices can be carried out using the Thermokon USEapp. The configuration is carried out in the voltage-supplied state.

The configuration-app and the app description can be found in the Google Play Store or in the Apple App Store.

## » DIMENSIONS (MM)

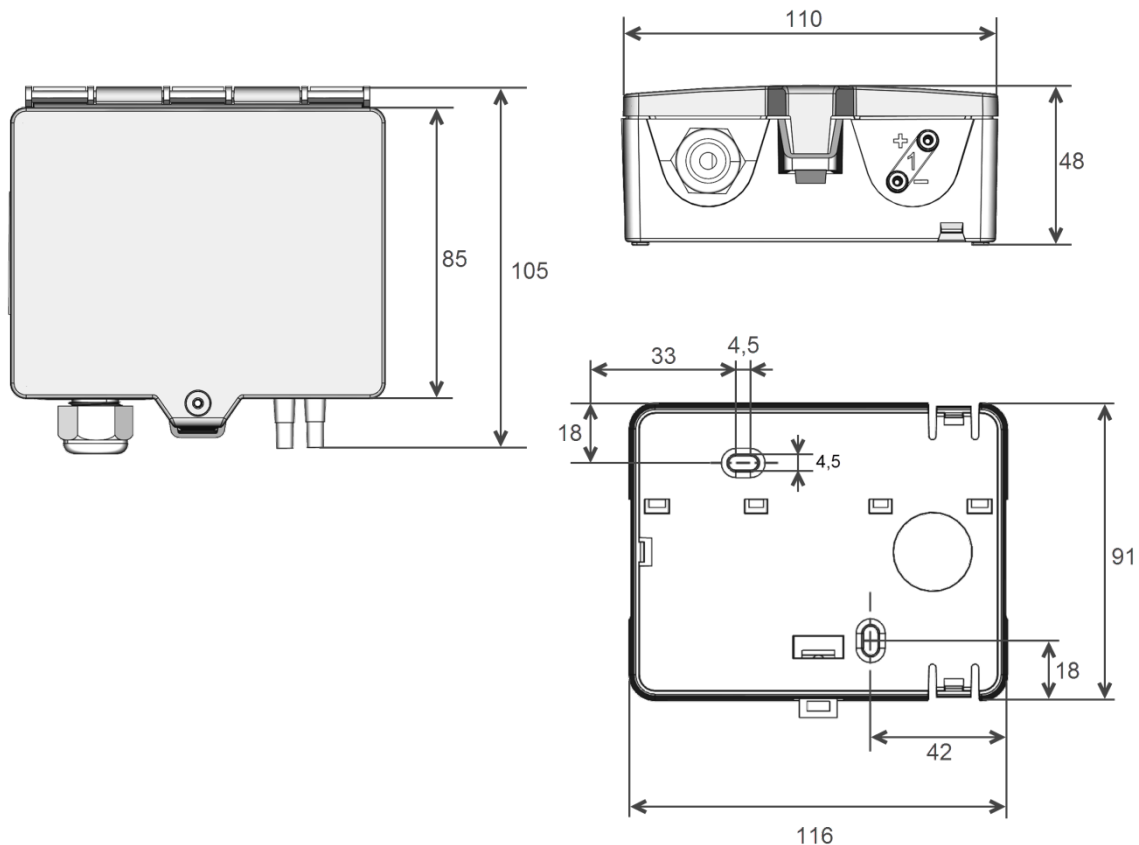

## » ACCESSORIES (INCLUDED IN DELIVERY)

Mounting base enclosure USE-L

2 m PVC connection tube

KKS40 kit

• 2 plastic duct flanges • 4 mounting screws 4x20

Item No. 668361

Item No. 484268

Item No. 430135

Mounting kit universal

• Cover screw + screw cover • 2 Rawplugs • 2 Screws (countersunk head) • 2 Screws (rounded head)

Item No. 698511

## » ACCESSORIES (OPTIONAL)

Bluetooth dongle USE for USEapp

Converter RS485 Modbus-USB incl. driver CD

T-hose connector for pressure hoses  $\varnothing=4$  mm (10 pcs)

Adapter 90° angle for pressure hoses  $\varnothing=4$  mm

Metal duct connectors 40 mm

Metal duct connectors 100 mm

Item No. 668262

Item No. 668293

Item No. 668323

Item No. 668330

Item No. 265138

Item No. 302531